

Rainwater harvesting

This document is one of a series of technical briefs produced by WaterAid.

Introduction

Where there is no surface water, or where groundwater is deep or inaccessible due to hard ground conditions, or where it is too salty, acidic or otherwise unpleasant or unfit to drink, another source must be sought. In areas which have regular rainfall the most appropriate alternative is the collection of rainwater, called 'rainwater harvesting'.

Falling rain can provide some of the cleanest naturally occurring water that is available anywhere. This is not surprising, as it is a result of a natural distillation process that is at risk only from airborne particles and from man-made pollution caused by the smoke and ash of fires and industrial processes, particularly those which burn fossil fuels.

Most modern technologies for obtaining drinking water are related to the exploitation of surface water from rivers, streams and lakes, and groundwater from wells and boreholes. However, these sources account for only 40% of total precipitation.

It is evident, therefore, that there is considerable scope for the collection of rainwater when it falls, before huge losses occur due to evaporation and transpiration and before it becomes contaminated by natural means or man-made activities.

The term 'rainwater harvesting' is usually taken to mean 'the immediate collection of rainwater running off surfaces upon which it has fallen directly'. This definition excludes run-off from land watersheds into streams, rivers, lakes, etc. WaterAid is concerned primarily with the provision of clean drinking water; therefore the rainwater harvesting projects which it supports are mainly those where rainwater is collected from roofs, and only to a lesser extent where it is collected from small ground, or rock, catchments.

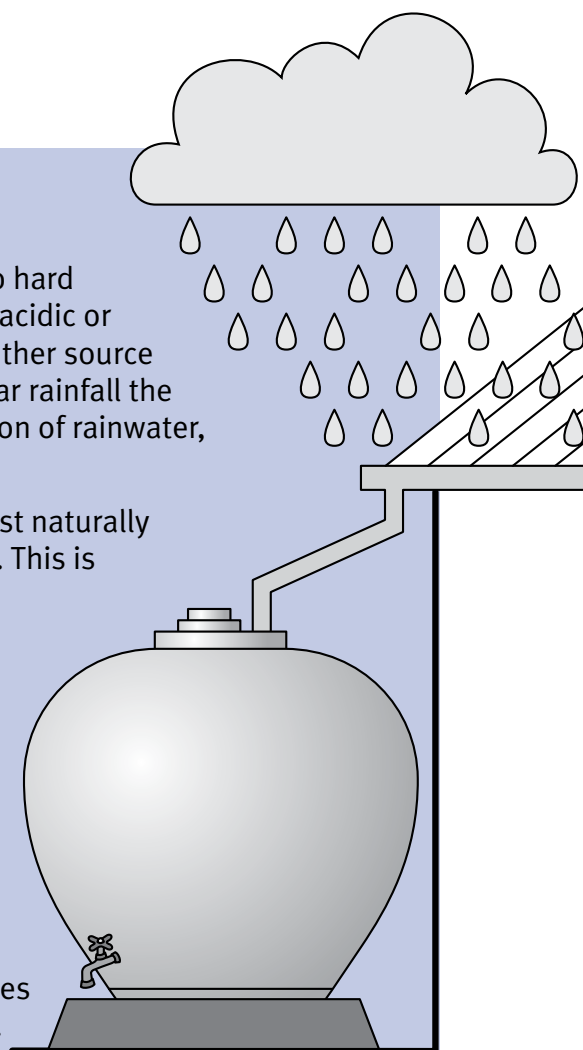

WaterAid's mission is to overcome poverty by enabling the world's poorest people to gain access to safe water, sanitation and hygiene education.

Advantages of rainwater harvesting

- ✓ Relatively cheap materials can be used for construction of containers and collecting surfaces
- ✓ Construction methods are relatively straightforward
- ✓ Low maintenance costs and requirements
- ✓ Collected rainwater can be consumed without treatment providing a clean collecting surface has been used
- ✓ Provides a supply of safe water close to homes, schools or clinics, encourages increased consumption, reduces the time women and children spend collecting water, reduces back strain or injuries from carrying heavy water containers

Disadvantages of rainwater harvesting

- ✗ Supplies can be contaminated by bird/animal droppings on catchment surfaces and guttering structures unless they are cleaned/flushed before use
- ✗ Poorly constructed water jars/containers can suffer from algal growth and invasion by insects, lizards and rodents. They can act as a breeding ground for disease vectors if they are not properly maintained

How it works

Roof catchments

Rainwater can be collected from most forms of roof. Tiled roofs, or roofs sheeted with corrugated mild steel etc are preferable, since they are the easiest to use and give the cleanest water. Thatched or palm leafed surfaces are also feasible; although they are difficult to clean and can often taint the run-off. Asbestos sheeting or lead-painted surfaces should be avoided.

The rainwater is collected in guttering placed around the eaves of the building. Low cost guttering can be made up from 22 gauge galvanised mild steel sheeting, bent to form a 'V' and suspended by galvanised wire stitched through the thatch or sheeting, as shown in the following diagram:

Section through typical gutter

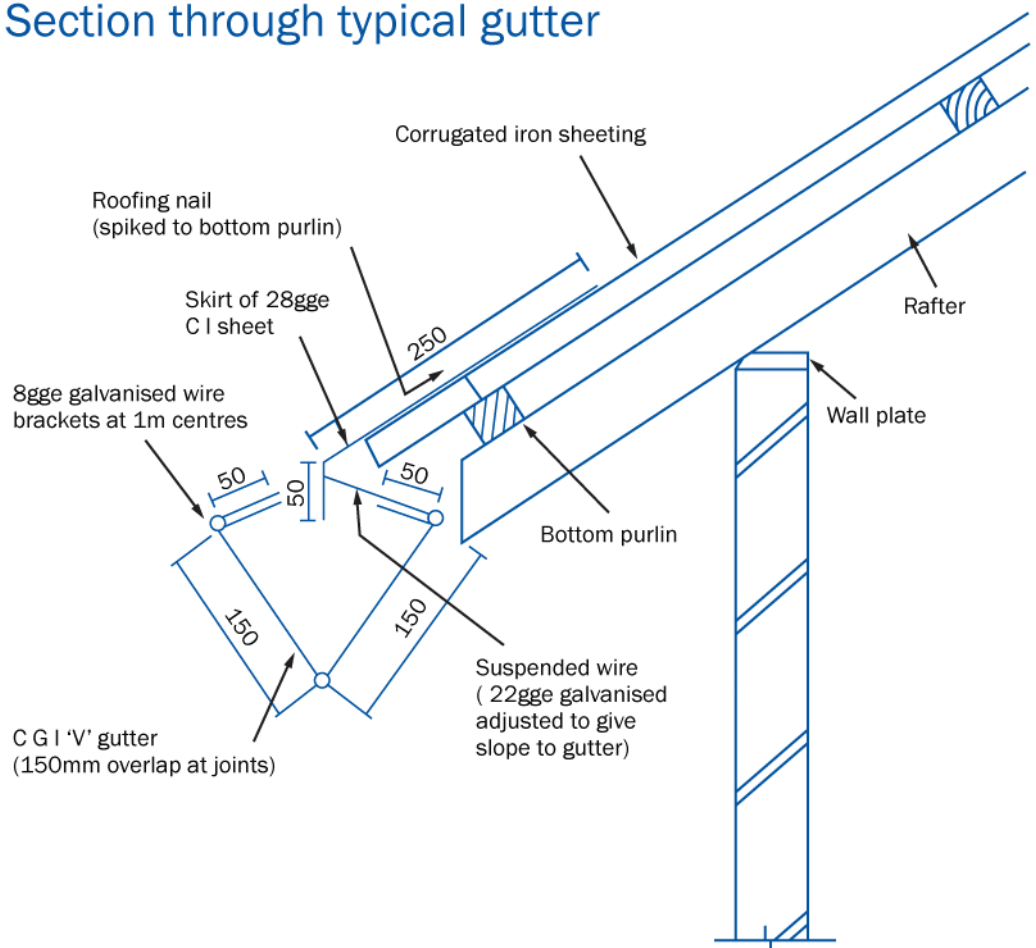

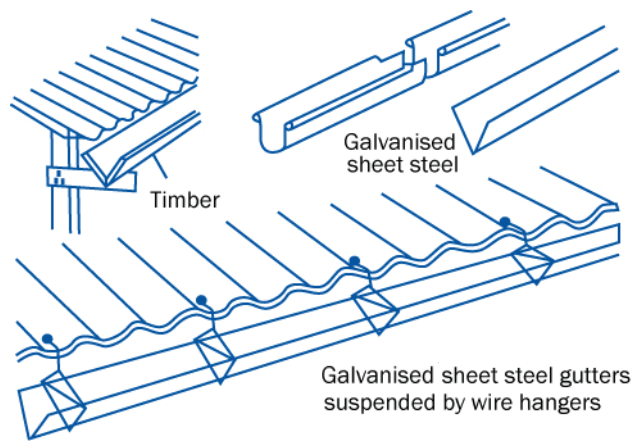

The guttering drains to a down-pipe which discharges into a storage tank. The down-pipe should be made to swivel so that the collection of the first run-off can be run to waste (the first foul flush), thus preventing accumulated bird droppings, leaves, twigs and other vegetable matter, as well as dust and debris, from entering the storage tank. Sometimes a collecting box with a mesh strainer (and sometimes with additional filter media) is used to prevent the ingress of potential pollutants.

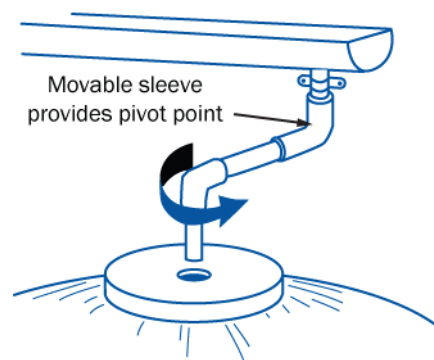

Alternatively, a foul flush box, which can be drained separately, may be fitted between the down-pipe and the storage tank. The run-off from a roof is directly proportional to the quantity of rainfall and the plan area of the roof. For every one millimetre of rain a square metre of roof area will yield one litre of water, less evaporation, spillage losses and wind effects. The guttering and downpipes should be sized so as to be capable of carrying peak volume of run off; in the tropics this can occur during high intensity storms of short duration.

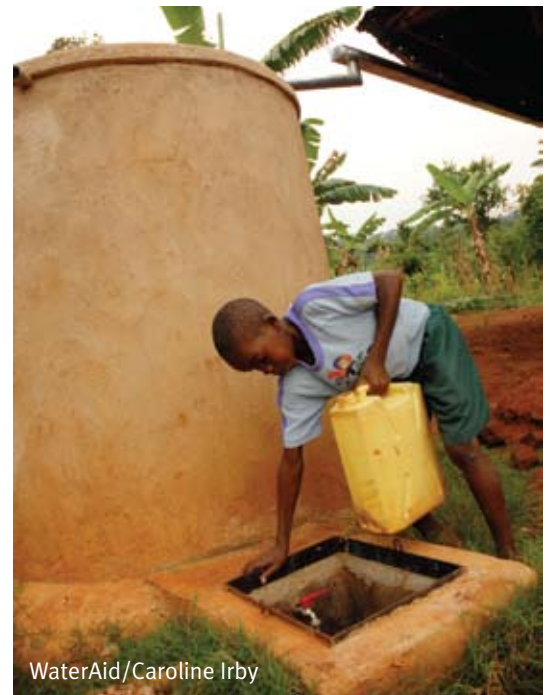

WaterAid/Caroline Irby

The storage tanks

The capacity of the storage tank is based upon several design criteria: rainfall patterns and volume, the duration of the dry period and, of course, the estimate of demand. Sometimes sophisticated calculations are involved, but these tend not to take into account human behaviour and the willingness to use water if it is available and not to conserve it for future use, in the hope that the dry spell will soon be over.

The following simple calculation can be used to approximate the potential supply of rainwater from a collecting surface. This can help to determine the capacity of storage tanks:

$$S = R \times A \times Cr$$

S = Mean rainwater supply in m³

R = Mean annual rainfall in mm/year

A = Surface area of catchment in m²

Cr = Run-off coefficient

The run-off coefficient accounts for losses due to splashing, evaporation, leakage and overflow and is normally taken to be 0.8.

The provision of the storage tank is the most costly element of a rainwater harvesting project, usually about 90% of the total cost. Storage can range from small containers made for other purposes, for example oil drums, food cans etc, but used as domestic storage, up to large tanks of 150 cubic metres or more at ground level, or sometimes beneath it. These tanks are made of concrete or ferrocement and are used as storage for schools, clinics or other institutions with large areas of roof.

Domestic storage tanks

Tanks for household use can be made cheaply in a variety of ways. 'Basket tanks' are baskets made of bamboo, originally intended for carrying or storing maize, which have been plastered internally and externally, in two stages, with sand/cement mortar. Storage of up to two cubic metres can be provided by such baskets. Corrugated galvanised mild steel sheeting, bent and welded or bolted into a circular plan, and often coated with sand/cement mortar, can provide similar storage capacity, but at a greater cost.

Tanks of larger capacity can be made of ferrocement, which substitutes chicken wire for the bamboo reinforcement of the basket tank. These are cheaper to construct than tanks made of masonry, blockwork, reinforced concrete etc, and do not require the rendering with waterproof cement mortar that masonry and blockwork often need.

Ferrocement tanks

Above ground level, tanks are constructed with a plain or reinforced concrete base, cylindrical walls of ferrocement and a roof of ferrocement, or sometimes mild steel sheeting. The construction of ferrocement walls is carried out by first assembling a cylindrical mesh of chicken wire and/or fence wire reinforcement, with or without the aid of formwork. On to this, a cement-rich mortar of 3:1 sand:cement is applied by trowel and built up in layers of about 15 millimetres to a finished thickness of between 30 to 100 millimetres, depending on wall height and tank diameter. Thicker walls may have two layers of mesh. The mesh helps to control local cracking and the higher walls may call for the provision of small

Eight year old Falida fills her jerry can at one of the two new 4000 litre capacity rainwater harvesting tanks at her school in Kitayita, Uganda. Previously, water had to be collected from an unprotected source half a kilometre away. These were the first jars constructed in the community and the exercise was used as a workshop to train local masons in jar construction.



WaterAid/Caroline Irby

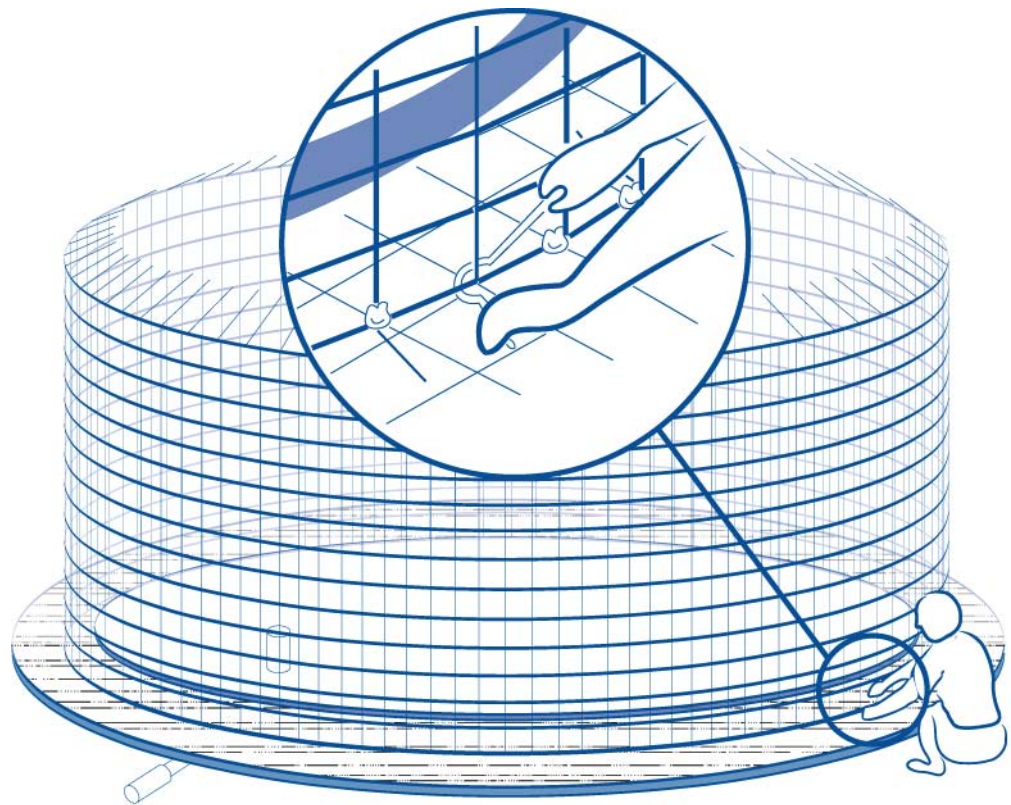

Wrapping the binding wire

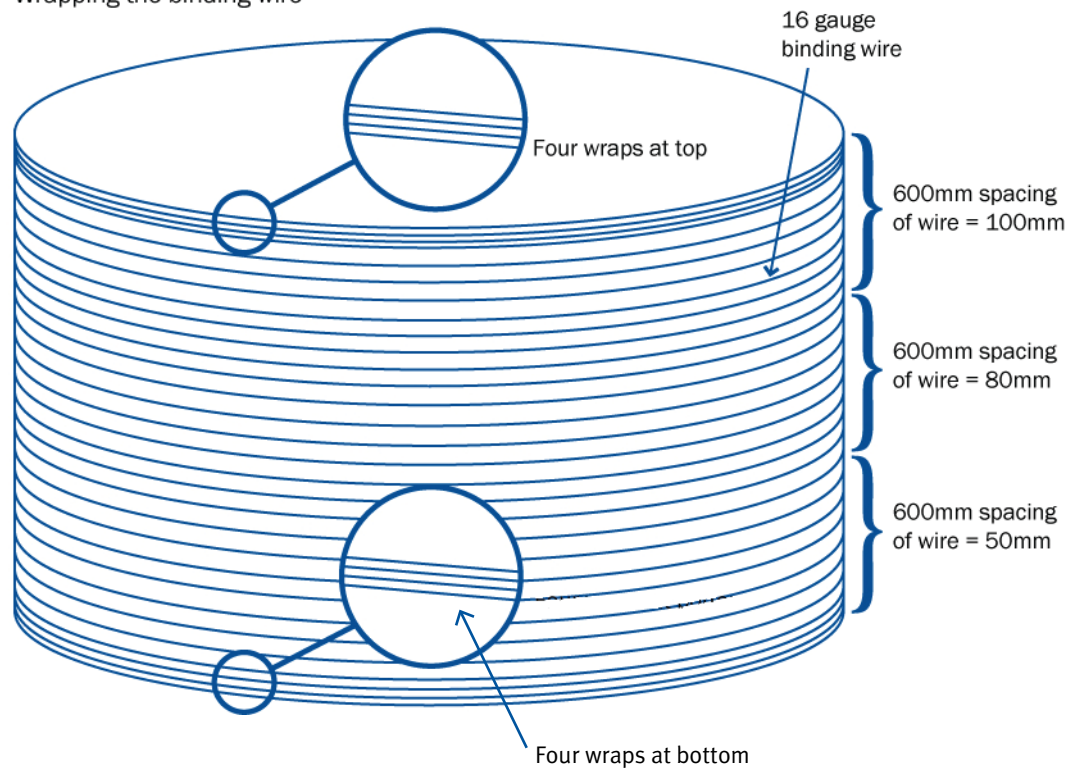

Standard design of a 23 cu.m. ferrocement tank

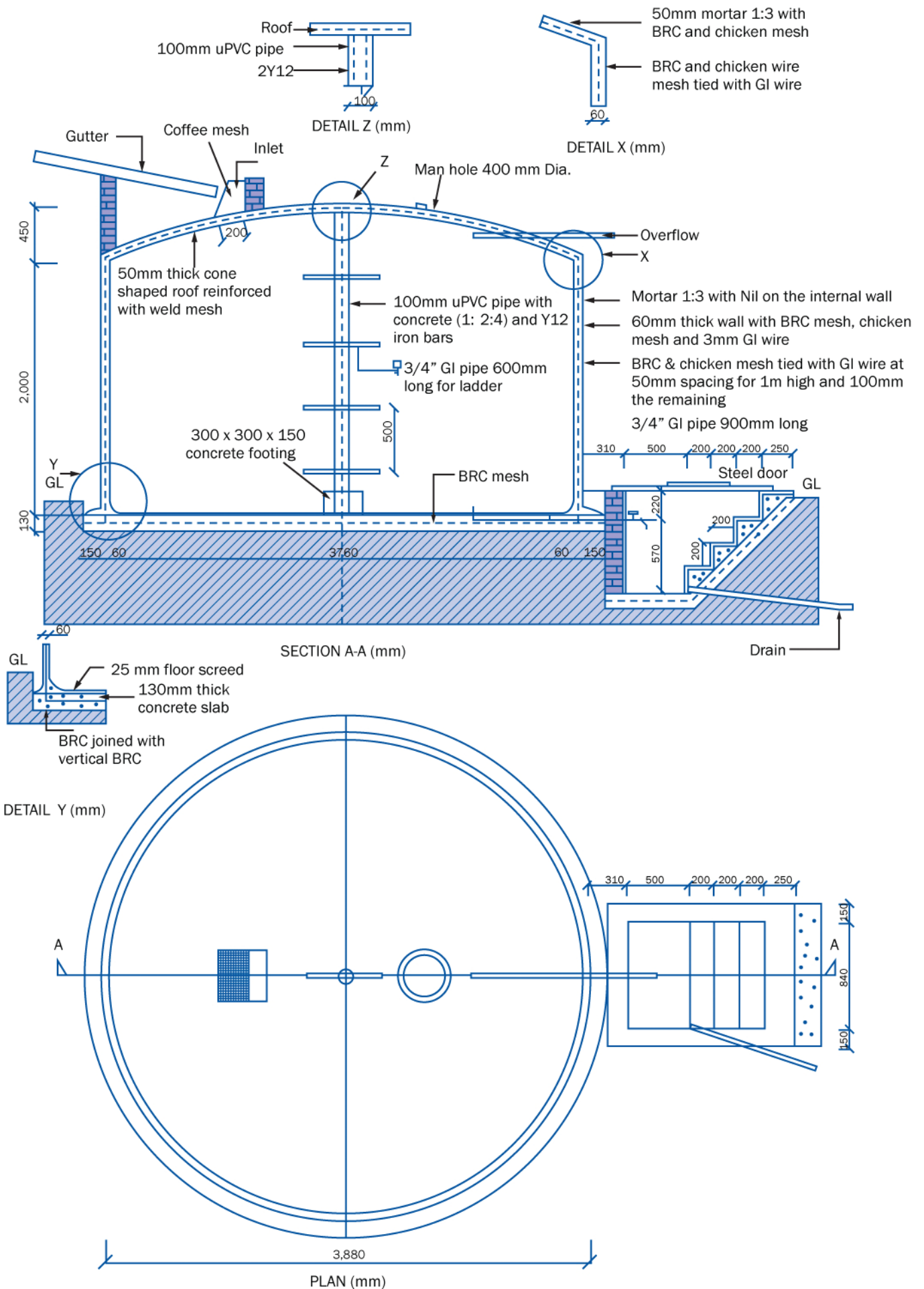



WaterAid/Chris Leake

A rainwater harvesting tank at a school in Guirhora Kello, Burkina Faso.

diameter vertical steel reinforcing bars for bending resistance. Sometimes barbed fence wire is wound spirally up the wall to assist with resistance to ring tension and stress distribution.

Effective curing of the mortar between the trowelling of each layer is very important and affects the durability of the material and its resistance to cracking. Mortar should be still green when the next layer is placed. This means that the time gap between layers should be between 12 and 24 hours. The finished material should then be cured continuously for up to 10 days under damp hessian, or other sheeting. A ferrocement tank is easy to repair and, if the mortar has been properly applied and cured, should provide long service as a water-retaining structure at a fraction of the cost of a reinforced concrete structure.

Rock catchments

Just as the roofs of buildings can be exploited for the collection of rainwater, so can rock outcrops be used as collecting surfaces. Indeed, if access to the catchment area by animals, children etc, can be prevented, a protected catchment can collect water of high quality, as long as its surfaces are well flushed and cleaned before storage takes place.

A significant proportion of Gibraltar's water is obtained from sloping rock catchments on the Rock. At the foot of the slopes, collecting channels drain into pipes which lead to tanks excavated inside the rock. Some artificial collection surfaces have also been formed: cracks and voids in rock surfaces have been filled in and a large, soil covered, sloping area has

been covered in corrugated mild steel sheeting supported on short piles driven into the subsoil. This is a huge example of what may be possible on a smaller domestic or village scale.

Sometimes it proves difficult to prevent the collected water from being polluted. If so, it is sensible to use this water for purposes that do not require a potable water supply, such as house cleaning, laundry, horticulture etc, and reserve for drinking water, cooking and personal hygiene the better quality water which has been collected from a clean roof.

Use can also be made of other forms of ground catchment where, although the collection coefficient can be as low as 30%, useful volumes of water can be collected and used for agriculture and animals.

References

Nissen-Petersen E (2007) *Water from roofs*, Danida

Gould G, Nissen-Petersen E (1999) *Rainwater catchment systems*, IT Publications, London

Pacey A, Cullis A (1986) *Rainwater harvesting: The collection of rainfall and run-off in rural areas*, IT Publications, London

Case study – Construction of household rainwater harvesting jars in Uganda

WaterAid has been working to improve household water supplies in a Ugandan village where 3,000 people lack access to safe water. The community is heavily affected by HIV/AIDS and there are many widows and single occupancy households. The terrain here is hilly, often with very steep gradients, making it difficult for the old or infirm to access safe water sources.

Local masons have been trained in the construction of rainwater harvesting jars. These jars are made from locally available materials and have a capacity of 1,500 litres which is equivalent to 75 jerry-cans of water. The objective has been to help the community construct on-site water supplies, close to the home, thus removing the need for the old or infirm to travel long distances across difficult terrain to collect water.

The jars have a long design life and once constructed can provide a stable water source for many years. There are two dry seasons and two wet seasons in this part of Uganda and the jars augment supply over the dry seasons, although the water inside may not last for the duration of a whole dry season.



WaterAid/Caroline Irby

Anna Maria Nanvubya and husband Zevilio Nakuzabasajja Kwafu constructing a rainwater harvesting jar at their home in Kitayita village, Uganda.





Materials required for construction:







- Locally made bricks for base (50)
- Three bags of sieved sand
- One bag of normal cement
- One kilogramme of waterproof cement
- A wooden mould that can be reused to make a number of jars
- One metre copper pipe
- One brass tap

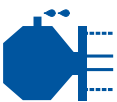

Construction methodology:

- Fifty bricks are used to assemble a stable platform upon which the jar is constructed.
- A one metre long copper pipe is shaped and laid in the brick base. This will channel water from the jar to the tap fitting.
- A reusable wooden mould is assembled from 12 component pieces on top of the brick base.
- The outside of the mould is smeared with mud for approximately three hours.
- It is left to stand for three days after which it is plastered with normal cement.
- The jar is left to dry for four days, giving time for the cement to set.
- After four days the mould is removed by extracting individual pieces from the mouth of the jar. The layer of mud inside the jar is also removed.
- The inside of the jar is then sealed using water proof cement.
- Community members provide guttering for their roofs and a plastic basin which is perforated to act as a filter at the top of the jar.
- Some jars have lockable tap chambers attached to their base to prevent theft of water.
- All jars are made in situ as they are fragile to transport. One jar costs around £35 to make. This cost can be shared between five households.

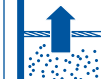
Water source options: See how rainwater harvesting compares to other water source options

	Water source	Capital cost	Running cost	Yield	Bacteriological water quality	Situation in which technology is most applicable
	Spring protection	Low or medium if piped to community	Low	High	Good if spring catchment is adequately protected	Reliable spring flow required throughout the year
	Sand dams	Low – local labour and materials used	Low	Medium/High – depending on method used to abstract water. Water can be abstracted from the sand and gravel upstream of the sand dam via a well or tubewell	Good if area upstream of dam is protected	Can be constructed across seasonal river beds on impermeable bedrock
	Sub surface dams	Low – local labour and materials used	Low	Medium/High – depending on method used to abstract water. Water can be abstracted from the sand, gravel or soil upstream of the sub-surface dam via a well or tubewell	Good if area upstream of dam is protected	Can be constructed in sediments across seasonal river beds on impermeable bedrock
	Infiltration galleries	Low – a basic infiltration gallery can be constructed using local labour and materials	Low	Medium/High – depending on method used to abstract water	Good if filtration medium is well maintained	Should be constructed next to lake or river
	Rainwater harvesting	Low – low cost materials can be used to build storage tanks and catchment surfaces	Low	Medium – dependent on size of collection surface and frequency of rainfall	Good if collection surfaces are kept clean and storage containers are well maintained	In areas where there are one or two wet seasons per year
	Hand-dug well capped with a rope pump	Low	Medium – spare parts required for pump	Medium	Good if rope and pump mechanisms are sealed and protected from dust. Area around well must be protected	Where the water table is not lower than six metres – although certain rope pumps can lift water from depths of up to 40 metres

	Hand-dug well capped with a hand pump	Medium	Medium – spare parts required for pump	Medium	Good if area around well is protected	Where the water table is not lower than six metres
	Tube well or borehole capped with a hand pump	Medium – well drilling equipment needed. Borehole must be lined	Medium – hand pumps need spare parts	Medium	Good if area around borehole/tubewell is protected	Where a deep aquifer must be accessed
	Gravity supply	High – pipelines and storage/flow balance tanks required	Low	High	Good if protected spring used as source	Stream or spring at higher elevation – communities served via tap stands close to the home
	Borehole capped with electrical/diesel/solar pump	High – pump and storage expensive	High – fuel or power required to run pump. Fragile solar cells need to be replaced if damaged	High	Good if source is protected	In a small town with a large enough population to pay for running costs
	Direct river/lake abstraction with treatment	High – intake must be designed and constructed	High – treatment and pumping often required. Power required for operation	High	Good following treatment	Where large urban population must be served
	Reverse osmosis	High – sophisticated plant and membranes required	High – power required for operation. Replacement membranes required	High	Good	Where large urban population must be served
	Household filters	High – certain filters can be expensive to purchase/produce	Filters can be fragile. Replacement filters can be expensive or difficult to source	Low	Good as long as regular maintenance is assured	In situations where inorganic contaminants are present in groundwater sources or protected sources are not available
	SODIS (solar disinfection)	Low – although clear bottles can be difficult to source in remote areas.	Low	Low	Good	In areas where there is adequate sunlight – water needs to be filtered to remove particulate matter that may harbour pathogens before SODIS can be carried out effectively. SODIS is not appropriate for use with turbid water

 = most preferable
  = preferable
  = least preferable

WaterAid's mission is to overcome poverty by enabling the world's poorest people to gain access to safe water, sanitation and hygiene education.



For more information, please contact:

WaterAid, 47-49 Durham Street,
London SE11 5JD, UK

Telephone: + 44 (0) 20 7793 4500

Fax: + 44 (0) 20 7793 4545

Email: wateraid@wateraid.org

Registered charity numbers
288701 (England and Wales)
and SC039479 (Scotland)

www.wateraid.org