

Protection of spring sources

Part of a series of WaterAid technology briefs.

Available online at www.wateraid.org/technologies

January 2013

Introduction

Surface springs occur where groundwater emerges at the surface because an impervious layer of rock prevents seepage downwards or where the water table is high enough to intersect a depression in the local topography.

A spring source can be used either to supply a gravity scheme or to provide a single outlet, running continuously, which is set at a sufficient height to allow a bucket or container to be placed below it. With the latter, to prevent waste, any flow which is surplus to that required for domestic use can be used for irrigation.

Fig 1: A protected spring

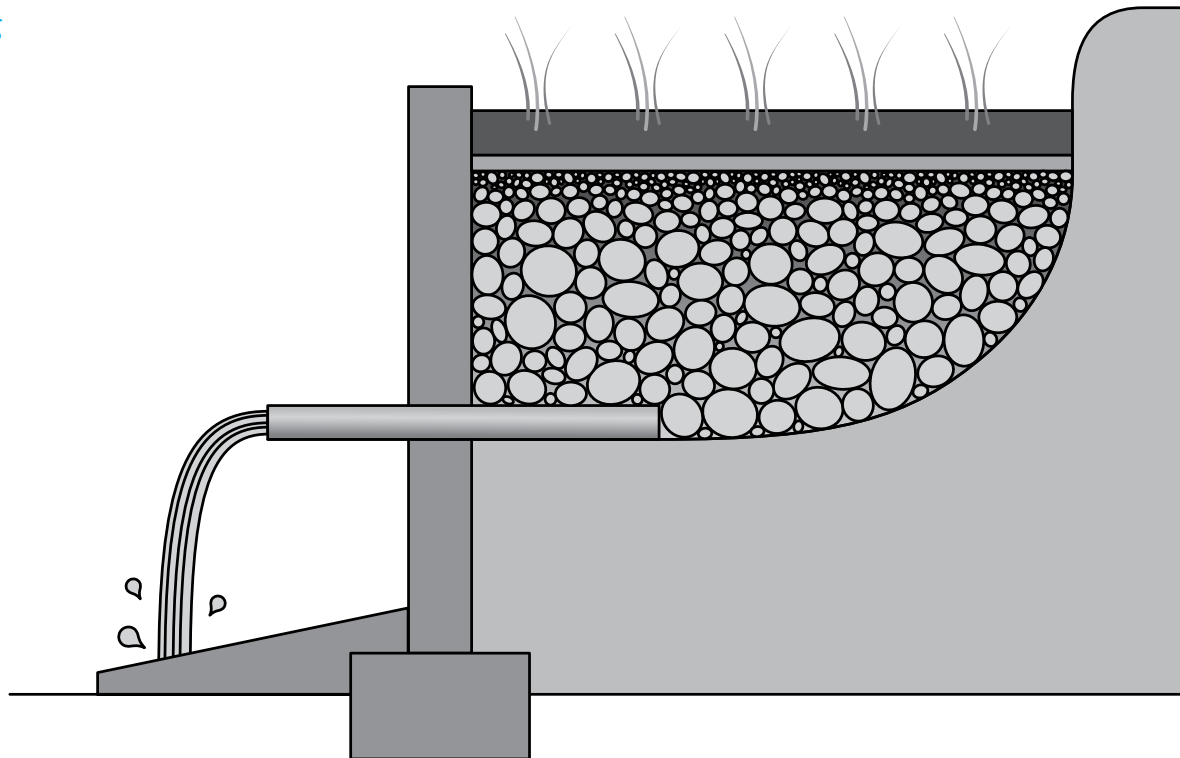

Advantages of spring protection schemes

- ✓ Water coming naturally to the surface limits need for pumping
- ✓ Low maintenance and running costs
- ✓ Can be high yielding source of good quality – no need for treatment

Disadvantages of spring protection schemes

- ✗ Yield can diminish or dry up during extreme drought periods
- ✗ Regular maintenance needed around the spring head to prevent pollution

Spring protection

Many different methods exist for getting the clear spring water from its source into the bucket or pipeline. These are described in detail in textbooks such as those provided in the reference section at the end of this paper. The essential matters are to protect the catchment of the spring and the spring head from pollution, and to arrange for the spring water to be delivered at a suitable height so that it falls with gravity directly into a container. An inspection of the ground upstream (catchment) of the spring is essential to ascertain that there is no danger of pollution or, if there is, what measures can be taken to prevent it.

The following points should be considered when investigating a potential spring source:

- Ensure the spring is not really a stream which has gone underground and is re-emerging.
- Ensure the source and the collection area are not likely to be polluted by surface run-off.
- Check that there are no latrines within 30 metres, particularly upstream of the spring.
- Fence the area around the spring tank to prevent pollution by children or livestock.
- Make sure that, if the spring is to be connected to a piped water system, it is on higher ground than the area to be supplied so the water will flow with gravity.

- Take care that the spring tank is not built on swampy ground or on land which is subject to erosion or flooding and that the flow from the protected spring itself will not cause erosion or damage.

Typical spring flow rates

The rate of water flow from the spring will vary with the seasons. It is necessary to measure the spring's flow at the end of the dry season to determine its potential reliable yield.

A flow in excess of 0.1 litres per second is sufficient to fill a 20 litre container in just over three minutes, which is an acceptable waiting time. From such a spring, a daily useful yield of about 3000 litres can be expected, which is enough water for about 150 people.

If the flow were to be only 0.05 litres per second it could still be made to supply the same population by incorporating a storage tank of one cubic metre capacity. This enables the flow from the spring over the full 24 hours to be stored, allowing enough water to be supplied at peak demands and throughout the day to meet intermittent demands by means of a tap in the structure.

If the flow is 0.5 litres per second or more, the source would be suitable to supply multiple outlets or a piped gravity scheme.

Stages in the protection of a spring

The following three diagrams illustrate the stages in the construction of a collecting chamber.

Stage one:

- Clear vegetation above the head of the spring
- Build a cut-off drain to divert surface water
- Divert the spring water temporarily to allow construction of the collection chamber

Stage two:

- Place large stones above the head of the spring
- Construct the collection chamber

Stage three:

- Further protection of the spring head by layers of impervious material above it

Fig 2: Stages of spring protection

Stage one

Plan view

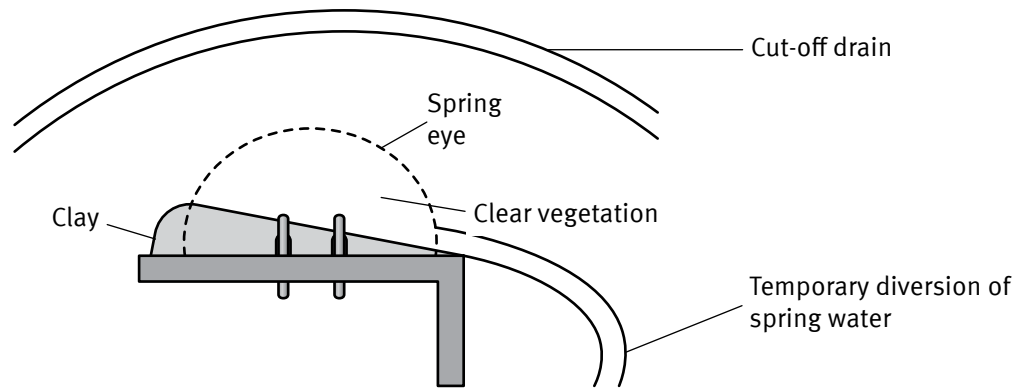

Stage two

Plan view

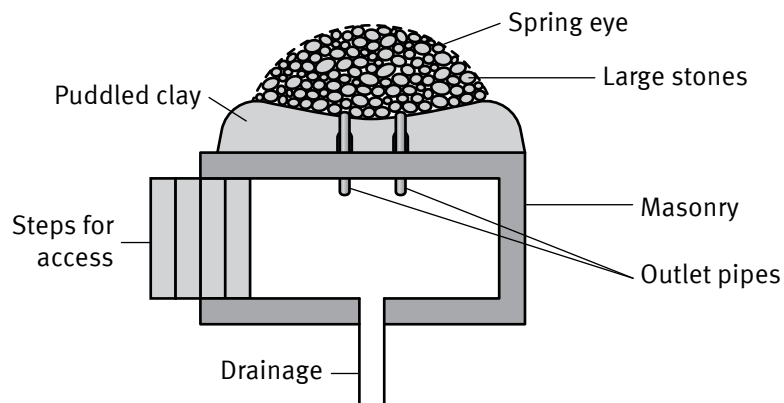

Stage three

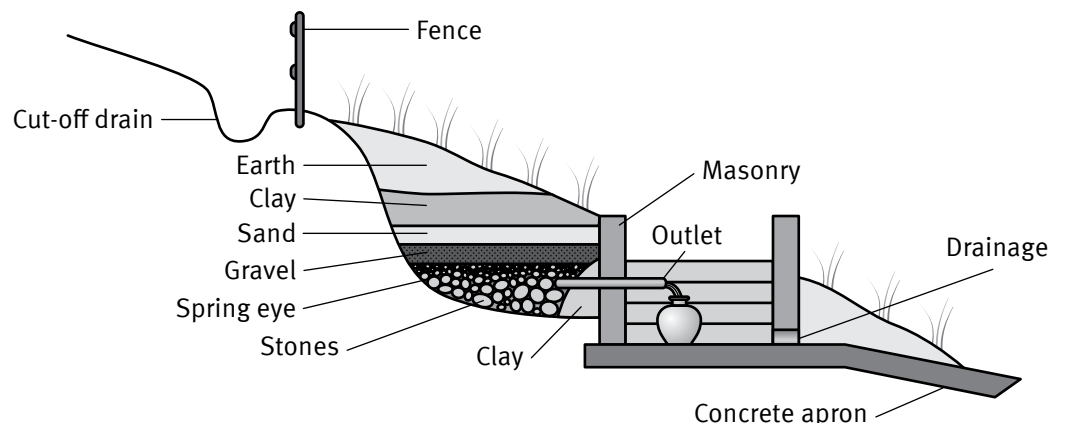

References

Davis J and Lambert R (1995) *Engineering in emergencies*. IT Publications

Pickford J (editor) (1991) *Worth of water*. IT Publications

Shaw R (1999) *Running water*. IT Publications

These three publications include more details on the protection of spring sources, as well as other aspects of water, sanitation and hygiene technologies.

Case study

Children collecting water at the spring in Kazo slum, Kampala, Uganda















Protection of a spring source in Kazo slum, Wakiso district in Kampala city, Uganda

Photo: WaterAid

Although Kazo slum is not far from the main road under which the city's water pipes run, the city water authority was not willing to pipe water to the slum. They didn't want to dig through the waterlogged ground of the slum – land which officially didn't belong to anybody – because they were worried about who would foot the bill.

In partnership with YIFODA (Youth Initiative for Development Association) WaterAid identified a spring in the slum which could be sealed and protected to establish it as a safe water source. The spring now bustles with life as hundreds of children come here every day carrying jerry cans of varying sizes to collect water for their families.

Water source options: See how spring protection compares to other water source options

	Water source	Capital cost	Running cost	Yield	Bacteriological water quality	Situation in which technology is most applicable
	Spring protection	Low or medium if piped to community	Low	High	Good if spring catchment is adequately protected	Reliable spring flow required throughout the year
	Sand dams	Low – local labour and materials used	Low	Medium/high – depending on method used to abstract water. Water can be abstracted from the sand and gravel upstream of the sand dam via a well or tubewell	Good if area upstream of dam is protected	Can be constructed across seasonal river beds on impermeable bedrock
	Sub surface dams	Low – local labour and materials used	Low	Medium/high – depending on method used to abstract water. Water can be abstracted from the sand, gravel or soil upstream of the sub-surface dam via a well or tubewell	Good if area upstream of dam is protected	Can be constructed in sediments across seasonal river beds on impermeable bedrock
	Infiltration galleries	Low – a basic infiltration gallery can be constructed using local labour and materials	Low	Medium/high – depending on method used to abstract water	Good if filtration medium is well maintained	Should be constructed next to lake or river
	Rainwater harvesting	Low – low cost materials can be used to build storage tanks and catchment surfaces	Low	Medium – dependent on size of collection surface and frequency of rainfall	Good if collection surfaces are kept clean and storage containers are well maintained	In areas where there are one or two wet seasons per year
	Hand-dug well capped with a rope pump	Low	Medium – spare parts required for pump	Medium	Good if rope and pump mechanisms are sealed and protected from dust. Area around well must be protected	Where the water table is not lower than six metres – although certain rope pumps can lift water from depths of up to 40 metres
	Hand-dug well capped with a hand pump	Medium	Medium – spare parts required for pump	Medium	Good if area around well is protected	Where the water table is not lower than six metres
	Tube well or borehole capped with a hand pump	Medium – well drilling equipment needed. Borehole must be lined	Medium – hand pumps need spare parts	Medium	Good if area around borehole/tubewell is protected	Where a deep aquifer must be accessed
	Gravity supply	High – pipelines and storage/flow balance tanks required	Low	High	Good if protected spring used as source	Stream or spring at higher elevation – communities served via tap stands close to the home
	Borehole capped with electrical/diesel/solar pump	High – pump and storage expensive	High – fuel or power required to run pump. Fragile solar cells need to be replaced if damaged	High	Good if source is protected	In a small town with a large enough population to pay for running costs
	Direct river/lake abstraction with treatment	High – intake must be designed and constructed	High – treatment and pumping often required. Power required for operation	High	Good following treatment	Where large urban population must be served
	Reverse osmosis	High – sophisticated plant and membranes required	High – power required for operation. Replacement membranes required	High	Good	Where large urban population must be served
	Household filters	High – certain filters can be expensive to purchase/produce	Filters can be fragile. Replacement filters can be expensive or difficult to source	Low	Good as long as regular maintenance is assured	In situations where inorganic contaminants are present in groundwater sources or protected sources are not available
	SODIS (solar disinfection)	Low – although clear bottles can be difficult to source in remote areas	Low	Low	Good	In areas where there is adequate sunlight – water needs to be filtered to remove particulate matter that may harbour pathogens before SODIS can be carried out effectively. SODIS is not appropriate for use with turbid water

 = most preferable

 = preferable

 = least preferable



WaterAid transforms lives by improving access to safe water, hygiene and sanitation in the world's poorest communities. We work with partners and influence decision-makers to maximise our impact.

Registered charity numbers:

Australia: ABN 99 700 687 141

Sweden: Org.nr: 802426-1268, PG: 90 01 62-9, BG: 900-1629

UK: Registered charity numbers 288701 (England and Wales) and SC039479 (Scotland)

US: WaterAid America is a 501(c)(3) non-profit organization